

# AMS-IX update

EPF '23 – Prague



# Better society through better internet



**It's keeping us busy...**



First PoP migrated to Juniper, today we start with the second!

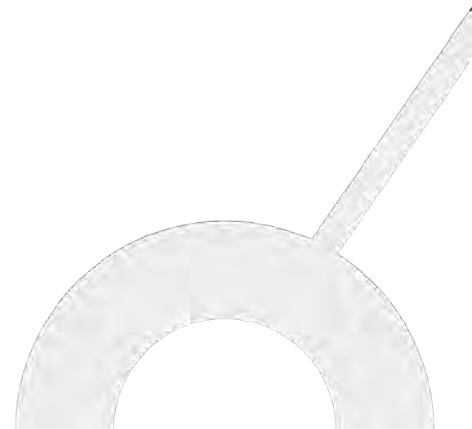

# Better society through better internet



**It's keeping us busy...**



First PoP migrated to Juniper, today we start with the second!



New customer portal in full swing: all Amsterdam and Carribean customers will be migrated this year.

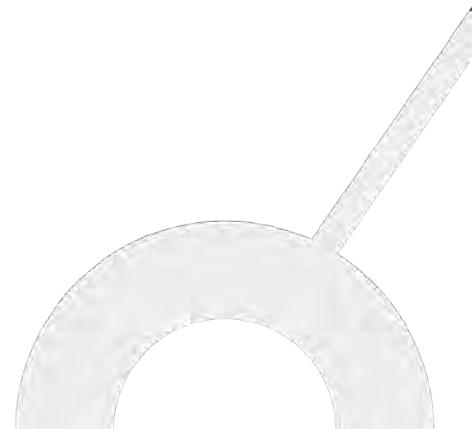

# Better society through better internet



**It's keeping us busy...**



First PoP migrated to Juniper, today we start with the second!



New customer portal in full swing: all Amsterdam and Carribean customers will be migrated this year.



Applied for an innovation grant to further develop the Amsterdam Data Exchange (with University of Amsterdam, SURF, Dexes, AMEC, KPMG)

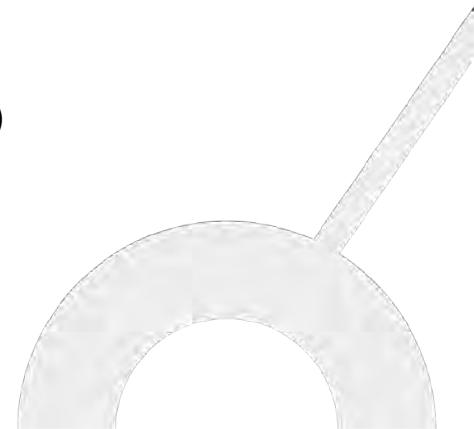

# Better society through better internet



**It's keeping us busy...**



First PoP migrated to Juniper, today we start with the second!



New customer portal in full swing: all Amsterdam and Carribean customers will be migrated this year.



Applied for an innovation grant to further develop the Amsterdam Data Exchange (with University of Amsterdam, SURF, Dexes, AMEC, KPMG)



Help develop new IX communities in the world in Cairo, Bangkok, Lagos, Kuching and a couple more in the pipeline

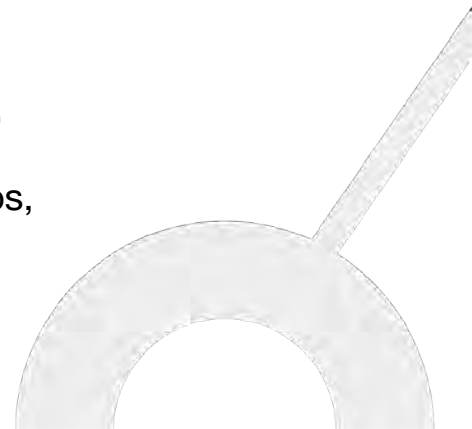

# Better society through better internet



**It's keeping us busy...**



First PoP migrated to Juniper, today we start with the second!



New customer portal in full swing: all Amsterdam and Carribean customers will be migrated this year.



Applied for an innovation grant to further develop the Amsterdam Data Exchange (with University of Amsterdam, SURF, Dexes, AMEC, KPMG)



Help develop new IX communities in the world in Cairo, Bangkok, Lagos, Kuching and a couple more in the pipeline



Collaborate with existing IX's

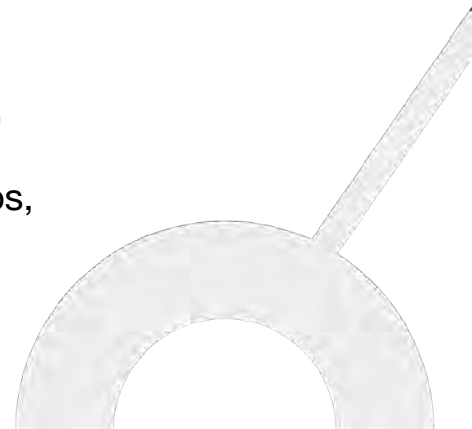

# 2023 Scenario: The market for data connectivity is evolving and changing the dynamics within the Internet Exchange landscape.

## Market dynamics

- Peering = Commodity
- Pricing is decreasing, also with IP Transit
- More IXP initiatives popping up globally
- Consolidation in DC market
- Hyperscalers investing heavily in (subsea) connectivity

## Scaling is needed

- To increase the value of the ecosystems
- To increase customer value
- To stay relevant

Current



Option 1  
Single IX  
approach



Option 2  
Cooperative  
approach  
(Cross-IX)



## Cross-IX:

Creating value for multiple Ecosystems, in a collaborative way



1

Lower barriers to reach more networks

2

Utilise existing relationships and contracts

3

Utilise existing ports (spare capacity)

4

Specifically designed for smaller volumes

*Aiming to start collaboration before the end of 2023*

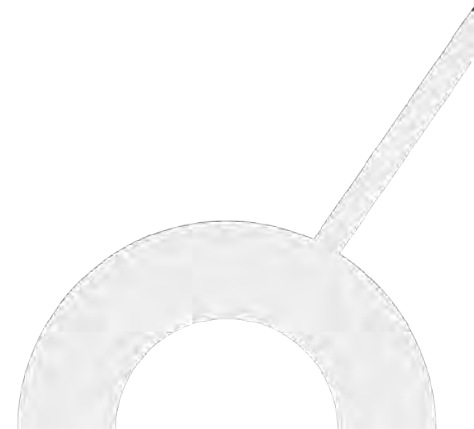



**Have a great  
EPF '23!**





**DECIX**

# **EPF 2023 – status quo**

---



---

Ivo Ivanov – CEO □ Thomas King – CTO  
September 2023

# Building & strengthening tomorrow's community

## Interconnection Academy – the knowledge exchange

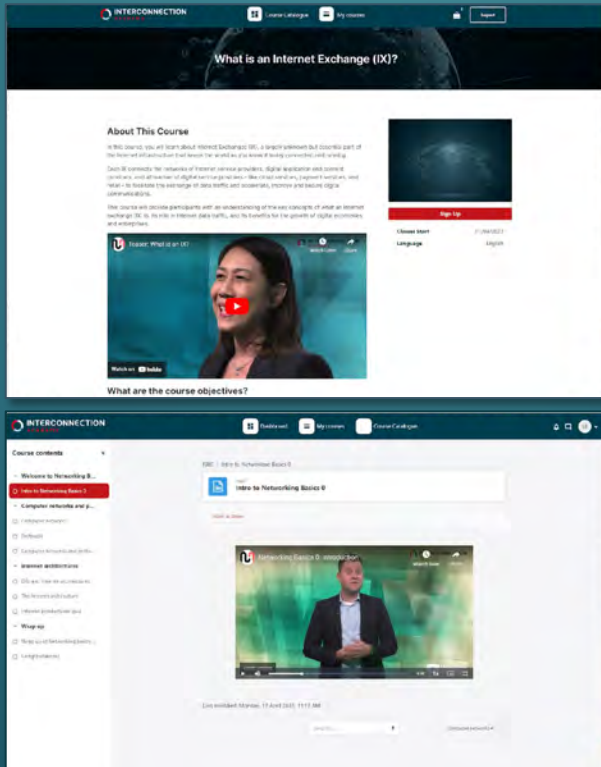

### For...

- Seasoned professionals looking to sharpen their skills on Interconnection topics
- Student from technical degrees eager to specialize on Interconnection
- Other business stakeholders: Data Centers, enterprises, etc

By... DE-CIX, Universitat Pompeu Fabra (UPF Barcelona), YOU and any expert of our industry eager to join the initiative and share their knowledge on selected topics

### With...

- Evolution of the Massive Open Online Courses format (MOOC), on
- Short videos, Quizzes
- Blockchain-verifiable certificate (coming soon)
- Free of charge



OPEN

### What is an Internet Exchange?

A 360° introduction: technical fundamentals and impact on enterprises

OPEN

### Networking Basics 0

Introduction to networks and protocols

### Networking Basics I

Ethernet, VLANs and IPs

### IX Trends and Innovations

Emerging technologies shaping the Internet

### Border Gateway Protocol (BGP)

Routing packets on the Internet



# Building & strengthening today's interconnection infrastructure

## 15 new locations in operations

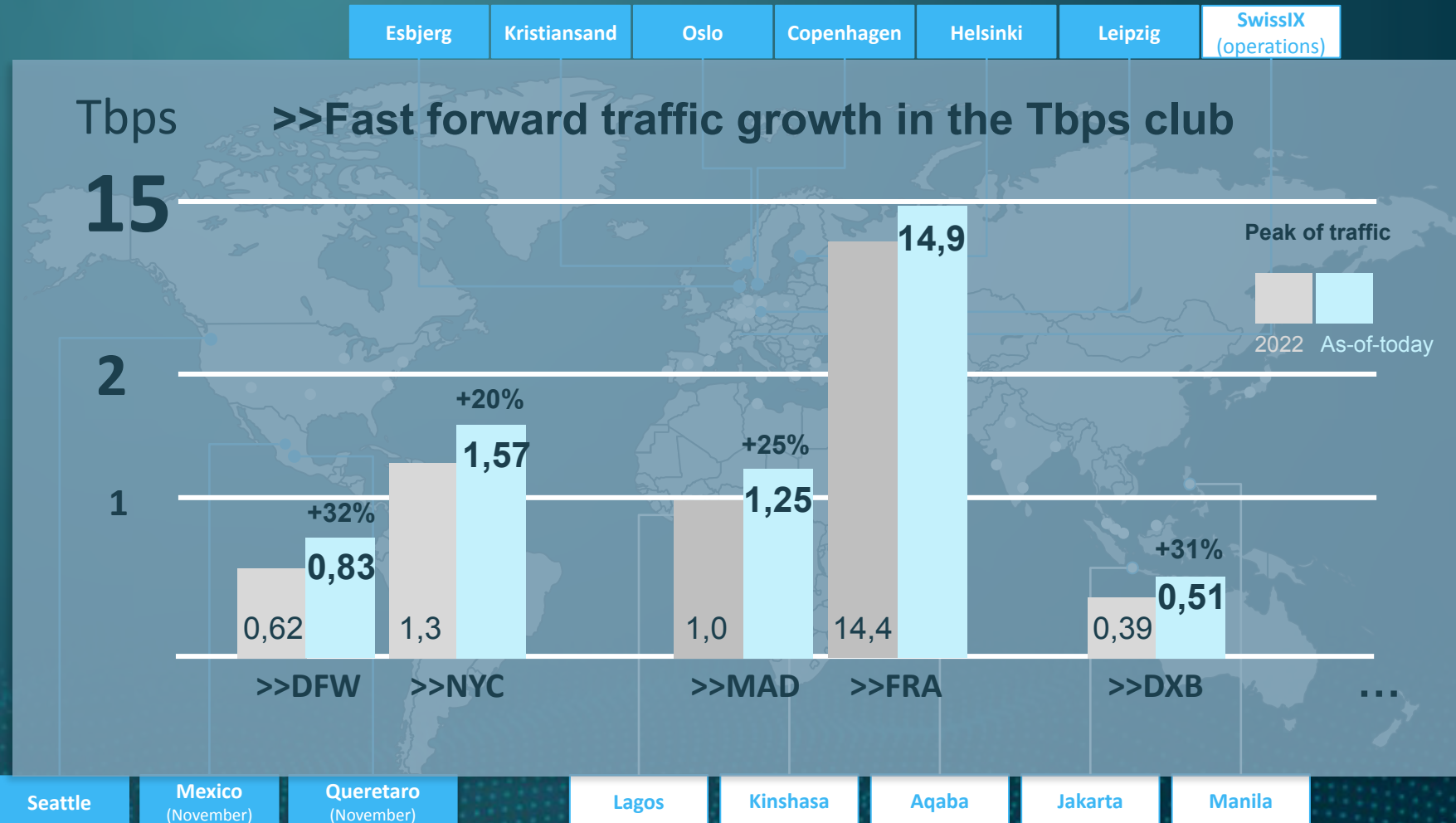

Own built  
partnership

# New services & technical features enabled at all or multiple DE-CIX locations

## Microsoft Azure Peering Service available @ 22 DE-CIX locations

CHI, DAL, NYC, PHX, SEA, LIS, BCN, MAD, MRS, AMS, DUS, FRA, MUC, OSL, CPH, HEL, IST, DXB, MUM, CHE, KUL, SIN



## New functionalities on the portal

New traffic stats for Access port & different interconnection services

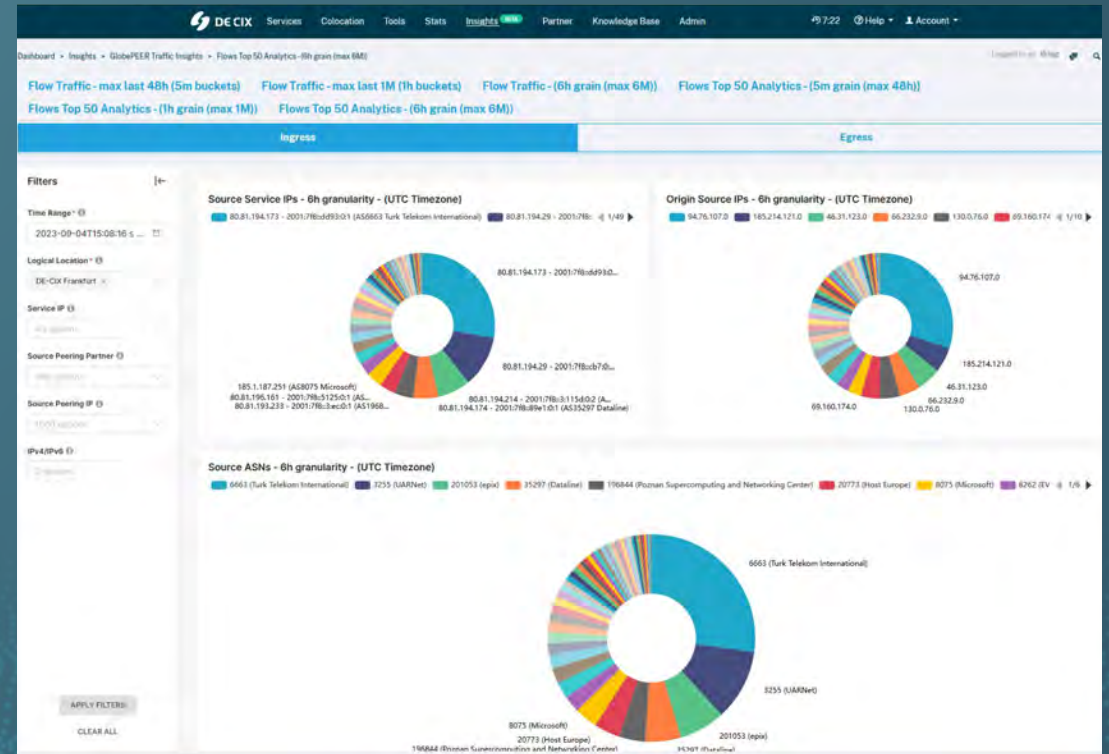





**DE CIX**

**Thank you!**



***We make interconnection easy. Anywhere.***



# LINX Update



**Kurt Erik Lindqvist**  
CEO

Monday 11<sup>th</sup> September 2023  
European Peering Forum





## News



### Expansion of MAPS

- MAPS now available at LINX Manchester and LINX NoVA in addition to London
- Simplest and fastest way to get direct peering with Microsoft (AS8075), independent of traffic levels or any other policy requirements
- Smaller prefixes than /24 also possible if needed



### Atlas Edge Strategic Partnership

- LINX will expand LINX Manchester to Atlas Edge's Salford site



### LINX Nairobi

- ADC announced as our second datacenter partner in Nairobi
- Also announced a strategic partnership to explore digital growth in Africa







## News

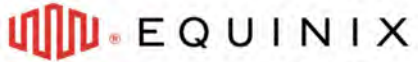

### LINX NoVA

- LINX and Equinix have announced that we are extending LINX NoVA to Equinix Ashburn IBX
- Nokia selected as partner for the refresh of the LINX NoVA platform



### LINX Portal

- Self-service and automation expanded

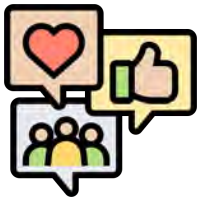

### Focus on high member engagement

- Sessions with members on future LINX direction and strategy
- Will continue with these sessions and engage with members
- The membership survey is open!





# Thank you



[linkedin.com/company/linx/](https://www.linkedin.com/company/linx/)



[facebook.com/LondonInternetExchange/](https://www.facebook.com/LondonInternetExchange/)



[twitter.com/linx\\_network](https://twitter.com/linx_network)



[youtube.com/user/LINXnetwork](https://www.youtube.com/user/LINXnetwork)

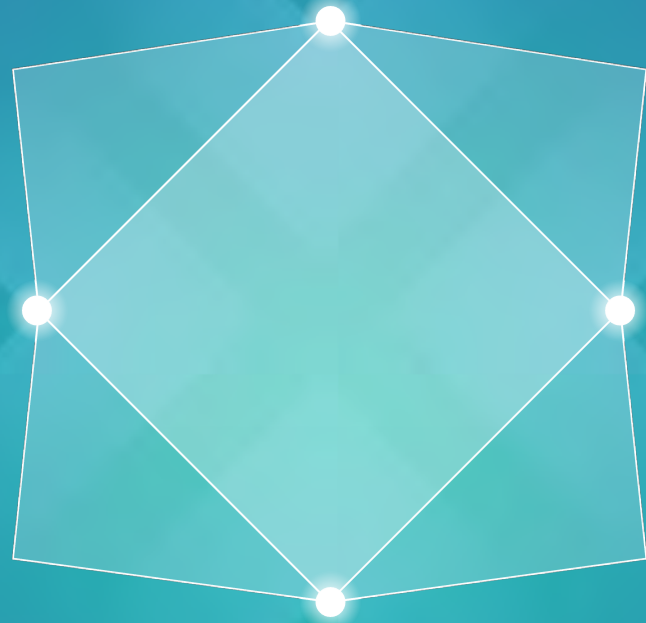

# Netnod update

## EPF 2023

Karin Ahl, CEO, Netnod

# The largest IX platform in the Nordics

- Market leader in Nordics
- Exchange local traffic, and easily scale across region
- Built for robustness: 100% uptime since 2002
- Value added services:
  - Netnod Time Direct
  - Closed User Group
  - Peer across Nordics with one port (Remote IX)
  - Cross-IX







## Shaped port

Pay only for the capacity you need with a flexible connection that scales with your network



## Remote IX

Use one Netnod IX port to peer throughout the Nordics



## Metro access

Get fully managed, immediately provisioned point-to-point transport in metro areas with multiple, redundant routes

# Netnod Time Direct - time-as-a-service

- A fully managed time service with SLA that guarantees 30 $\mu$ s accuracy from UTC
- Delivered over cross-connect or IX port
- Immediate provisioning and easy integration with current setup

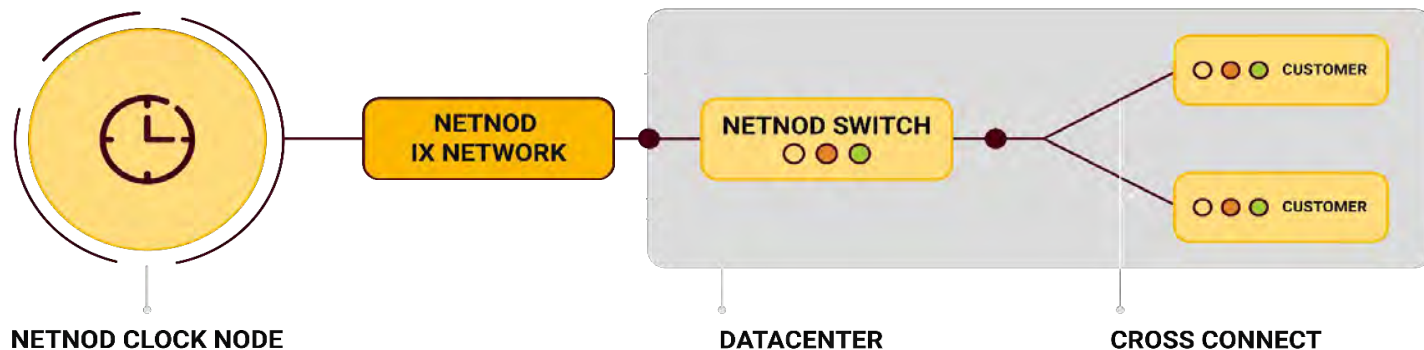

# Netnod IX Stockholm



- Largest IX in Nordics
- 195+ networks
- 2+ Tbps peak traffic



# Netnod IX Copenhagen

- Fastest growing IX in the region
- 60+ networks
- 475+ Gbps peak traffic
- Malmö / Copenhagen  
interconnected with multiple,  
redundant paths







**Patrik Fältström, team leader for Team Sweden-Iceland, Major in the Swedish Armed Forces, and Head of Security at Netnod.**

A dark, wide-angle photograph of a conference room. In the foreground, many people are seated at long tables, facing towards the back of the room. The room is dimly lit, with circular light fixtures on the ceiling. A speaker is visible on a stage in the background. The text "Thanks for listening!" is overlaid in large white font in the center of the image.

# Thanks for listening!